



Lighting

# APPLICATION BRIEF



## High Intensity Discharge (HID) Lamp



High Intensity Discharge (HID) lamps cast a large amount of light over a large area in an energy efficient manner. A key system function is the ballast which is required to start and sustain a controlled energy arc for the lamp. Central Semiconductor manufactures discrete components that maximize the efficiency, performance and reliability of today's energy conscious HID ballast systems.

For more information visit: [www.centrasemi.com/product/hid](http://www.centrasemi.com/product/hid)



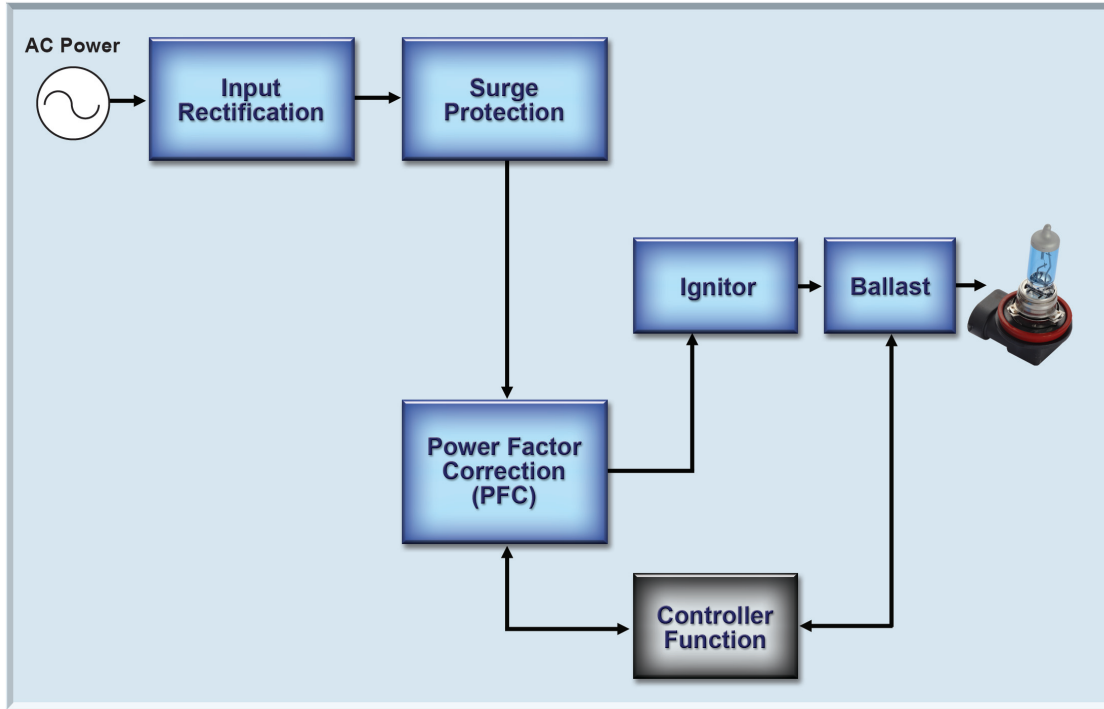

### High Intensity Discharge (HID) Lamp Topology



#### Input Rectification

##### • Bridge Rectifiers (Full Wave)



-  - CBRLD1-06: 1.0A, 600V low profile package (LPDIP)
-  - CBR2-D060S: 2.0A, 600V (SMDIP)
-  - CBR6M-L060: 6.0A, 600V (DM in-line)
-  - CBR8M-L060: 8.0A, 600V (DM in-line)
-  - CBR25-060P: 25A, 600V (FP)

For more information visit: [www.centrasemi.com/apps/ir17](http://www.centrasemi.com/apps/ir17)

#### Surge Protection

##### • Transient Voltage Suppressors (TVS)



-  - 3SMC170CA: 3000W Peak, 170V bi-directional, 5% TVS (SMC)
- 1.5SMC170CA: 1500W Peak, 170V bi-directional, TVS (SMC)
- 1.5SMC200CA: 1500W Peak, 200V bi-directional, 5% TVS (SMC)
- 1.5SMC220CA: 1500W Peak, 200V bi-directional, 5% TVS (SMC)

For more information visit: [www.centrasemi.com/apps/sp17](http://www.centrasemi.com/apps/sp17)

weblink scan

Use QR reader for direct link to application web page.









Lighting

# High Intensity Discharge (HID) Lamp

## Power Factor Correction (PFC)



### • Rectifiers



-  CMR3S-06: 3A, 600V, 35ns Super Fast Rectifier (SMC)
-  CMR5H-06: 5A, 600V, 25ns HyperFast Rectifier (SMC)
-  CHD8-06: 8A, 600V, 25ns HyperFast Rectifier (DPAK)
-  CTLHR10-06: 10A, 600V, 25ns HyperFast Rectifier (TLM364)
-  CUD10-06: 10A, 600V, 35ns, Ultra Fast Rectifier (DPAK)

### • MOSFETs







-  CDM4-650: 4A, 650V, N-Channel (DPAK)
-  CDM7-650: 7A, 650V, N-Channel (DPAK)

For more information visit: [www.centrasemi.com/apps/pfc17](http://www.centrasemi.com/apps/pfc17)

## Ignitor

### • Rectifiers







-  CMR5H-06: 5A, 600V, 25ns HyperFast Rectifier (SMC)
-  CHD8-06: 8A, 600V, 25ns HyperFast Rectifier (DPAK)
-  CTLHR10-06: 10A, 600V, 25ns HyperFast Rectifier (TLM364)
-  CUD10-06: 10A, 600V, 35ns, Ultra Fast Rectifier (DPAK)

For more information visit: [www.centrasemi.com/apps/i17](http://www.centrasemi.com/apps/i17)

## Ballast



### • Rectifiers



-  CMR5H-06: 5A, 600V, 25ns HyperFast Rectifier (SMC)
-  CHD8-06: 8A, 600V, 25ns HyperFast Rectifier (DPAK)
-  CTLHR10-06: 10A, 600V, 25ns HyperFast Rectifier (TLM364)
-  CUD10-06: 10A, 600V, 35ns, Ultra Fast Rectifier (DPAK)

### • MOSFETs



-  CDM4-650: 4A, 650V, N-Channel (DPAK)
-  CDM7-650: 7A, 650V, N-Channel (DPAK)

For more information visit: [www.centrasemi.com/apps/b17](http://www.centrasemi.com/apps/b17)

For more information visit Central's Lighting applications page: [www.centrasemi.com/apps/lighting](http://www.centrasemi.com/apps/lighting)

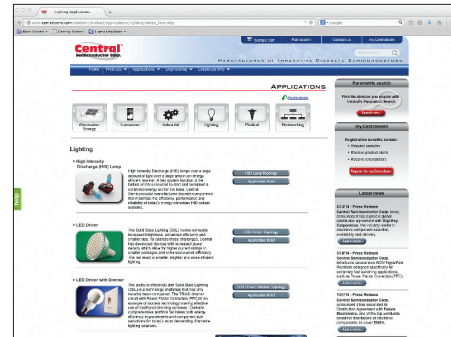

## Samples



To order samples of these devices visit:  
<http://web.centrasemi.com/search/sample.php>

## Literature



New  
SMD  
SELECTION  
GUIDE

Order your selection guide today.  
Visit: [web.centrasemi.com/search/sample.php](http://web.centrasemi.com/search/sample.php)



**Innovative Discrete  
Semiconductors**

For further information contact:  
Sales at Central Semiconductor Corp.  
(631) 435-1110 or visit:  
[www.centrasemi.com](http://www.centrasemi.com)

145 Adams Avenue, Hauppauge, New York, 11788, USA