

PoE Security Camera



Since the amount of source current available to drive Powered Devices (PDs) is limited in PoE systems, the utilization of energy efficient semiconductors is critical. Central Semiconductor manufactures discrete semiconductor solutions that minimize total conduction losses, which greatly assists engineers in enhancing the overall energy efficiency of PDs.

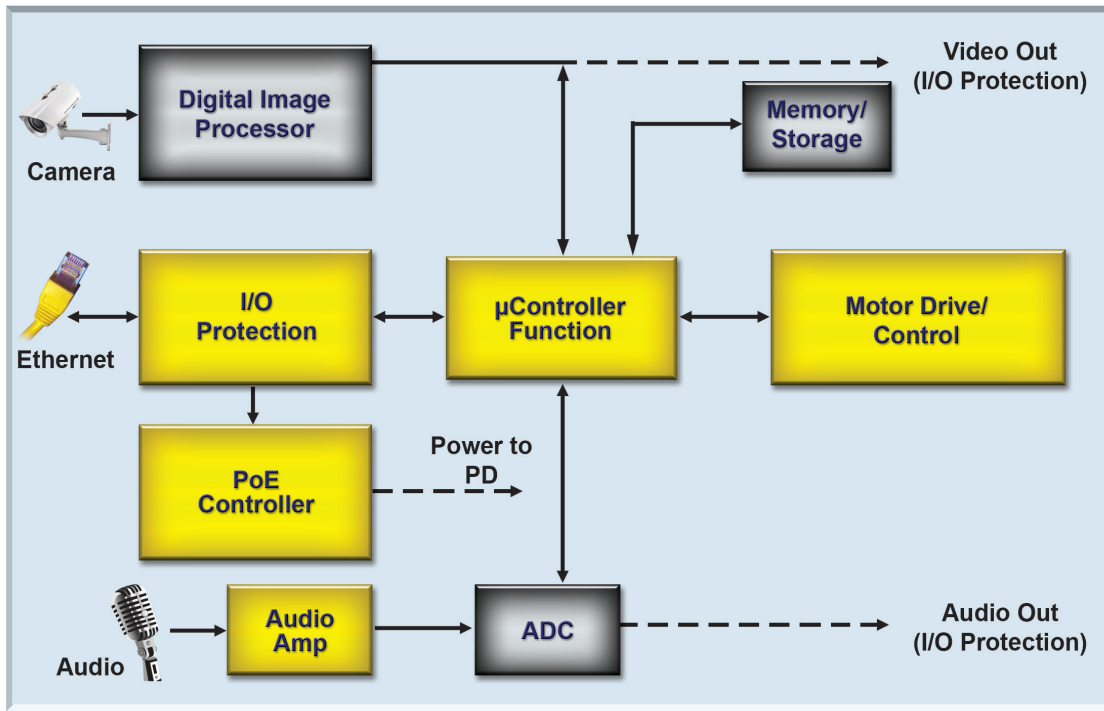

For more information visit: www.centrasemi.com/applications

PoE Security Camera Topology



I/O Protection

- Transient Voltage Suppressors (TVS) 

-  - C4SMAFL58A: 58V, 400W TVS (SMAFL)
-  - 1SMB58CA: 58V, 600W bi-directional TVS (SMB)
-  - 1.5SMC68CA: 58.1V (stand-off), 1500W bi-directional TVS (SMC)

Audio Amp

- MOSFETs 

-  CMLDM7002AG: Dual 280mA, 60V, N-Channel MOSFET (SOT-563)
-  CMLDM8002AG: Dual 280mA, 50V, P-Channel MOSFET (SOT-563)

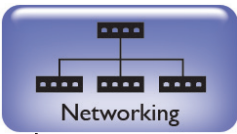

- Zener Diodes 

-  - CMOZ5L1: 5.1V, 250mW, low idle current Zener diode (SOD-523)





µController Function

• Zener Diodes





-  CMOZ5L1: 5.1V, 250mW, low idle current Zener diode (SOD-523)
-  CMOZ12L: 12V, 250mW low idle current Zener diode (SOD-523)
-  - CMDZ5L1: 5.1V, 250mW, low idle current Zener diode (SOD-323)

• Transient Voltage Suppressors (TVS)



-  - CFTVS5V0LC: 5V, low capacitance, low profile ESD TVS protector (SOD-882L)
-  - CMO5V0LC: 5V, low capacitance, low profile ESD TVS protector (SOD-523)
-  - CMATVS3V3: 3.3V ESD TVS protector (SOD-923)

Motor Drive / Control

• MOSFETs

-  CMLDM8005: 650mA, 20V, Dual P-Channel MOSFETs (SOT-563)
-  CMLDM7005: 650mA, 20V, Dual N-Channel MOSFETs (SOT-563)
-  CEDM8004: 450mA, 30V, low profile P-Channel MOSFET (SOT-883L)
-  CEDM7002AE: 300mA, 20V, low profile N-Channel MOSFET (SOT-883L)

• Zener Diodes



-  CMOZ5L1: 5.1V, 250mW, low idle current Zener diode (SOD-523)
-  CMOZ12L: 12V, 250mW low idle current Zener diode (SOD-523)







• Low Leakage Diode

-  - CFD4448: 250mA, 120V, low leakage, low profile Diode (SOD-882L)



PoE Controller

• Schottky Bridge Rectifiers Full Wave



-  CBRHDSH1-100: 1A, 100V Schottky Bridge (HD DIP)
-  CBRHDSH2-100: 2A, 200V Schottky Bridge (HD DIP)
-  - CBRLDSH2-100: 2A, 100V Schottky Bridge (LPDIP)

-  CBRDFSH1-40: 1.0A, 40V (BR DFN)
-  CBRDFSH1-60: 1.0A, 60V (BR DFN)
-  CBRDFSH1-100: 1.0A, 100V (BR DFN)
-  CBRDFSH2-40: 2.0A, 40V (BR DFN)
-  CBRDFSH2-60: 2.0A, 60V (BR DFN)
-  CBRDFSH2-100: 2.0A, 100V (BR DFN)
-  CBRDFSH3-40: 3.0A, 40V (BR DFN)
-  CBRDFSH3-60: 3.0A, 60V (BR DFN)

• Zener Diodes

-  - CMOZ5L1: 5.1V, 250mW, low idle current Zener diode (SOD-523)
-  - CMDZ5L1: 5.1V, 250mW, low idle current Zener diode (SOD-323)

• MOSFETs

-  CEDM7002AE: 300mA, 20V, low profile N-Channel MOSFET (SOT-883L)
-  CEDM8004: 450mA, 30V, low profile P-Channel MOSFET (SOT-883L)

For more information on Central's products and potential solutions:

Call us at: **1.631.435.1110**

Or view online: www.centralsemi.com

